

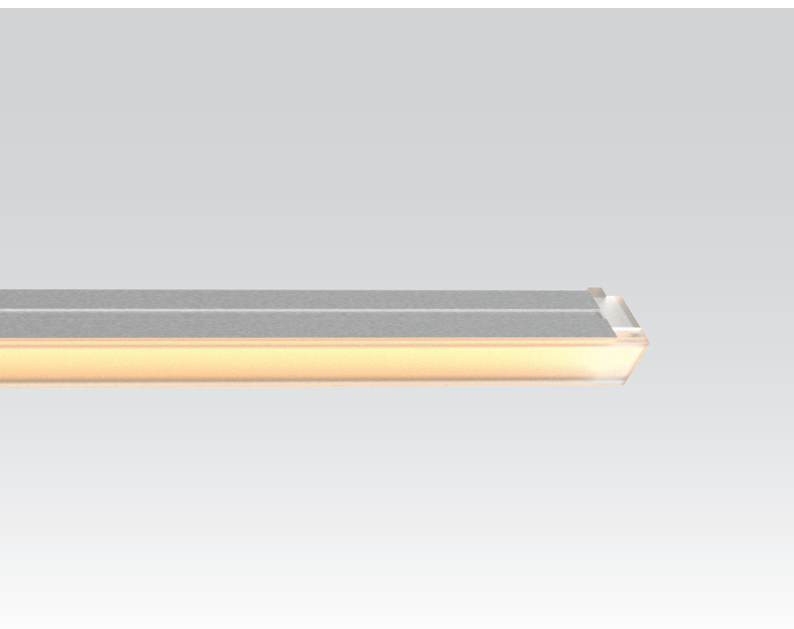







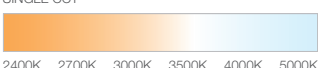

LP10F

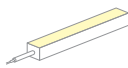
FLAT LINEAR PROFILE LUMINAIRE



AVAILABLE OPTIONS	
COLOUR OPTIONS	SILVER ANODIZED 
CCT OPTIONS	SINGLE CCT   2400K 2700K 3000K 3500K 4000K 5000K ProART
WIRE END & EXIT CONFIGURATIONS OPTIONS	  <p>Single Wire End, End Cap Exit Double Wire End, End Cap Exit</p>
ACCESSORIES	   <p>Mounting Clip UniLink Mounting Clip FlexiLink Mounting Clip</p>

DIMENSIONS (MM)

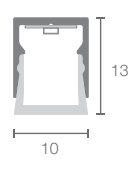

PHOTOMETRICS

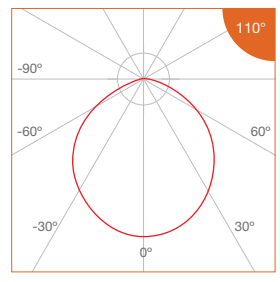



Joinery _Indoor Lighting

Profile Type	10mm width aluminium linear profile
Profile Finishing	Silver Anodised
Cover	Diffused
Light Uniformity	Dot-less
Mounting	Surface, with stainless steel mounting clip
Beam Angle	110°
Compatible LED Module	FM5
CRI	ProART (CRI~95)
SDCM	3 step MacAdam ellipse binning
Lifetime	Up to 50,000 hours L80 lamp life at Ta = 25°C
Voltage	24V DC
Maximum Power	15W/m
Length Options	501mm or 1000mm
Operating Temperature	Ta (min) = -25°C, Ta (max) = +50°C
Wire Connection	Supplied with insulated wires at 150mm length
IP Rating	IP40 or IP54
Profile LOR	57%

SPECIFICATIONS

CCT	Efficacy (lm/W)	Default (Max.) 15W/m	Luminous Flux per meter (lm/m)							
			With CVMPS150 Dip Switch Settings *							
			On "8"	On "7"	On "6"	On "5"	On "4"	On "3"	On "2"	On "1"
2400K	53.9	809	728	647	566	485	404	324	243	162
2700K										
3000K	62.7	941	846	752	658	564	470	376	282	188
3500K										
4000K	65.8	988	889	790	691	593	494	395	296	198
5000K										
Correction Factor		1.00	0.90	0.80	0.70	0.60	0.50	0.40	0.30	0.20

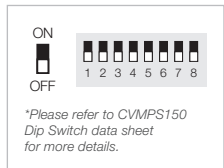

ORDERING MATRIX

Profile	Finishing		Cover		Length		LED Module Power & CCT			Wire End & Exit Configuration		Ingress Protection		
LP10F	SL	Silver Anodised	D	Diffused	500	500mm	15	15W/m	24	2400K	SE	Single Wire End, End Cap Exit	IP40	IP40
					1000	1000mm			27	2700K				
									30	3000K				
									35	3500K				
									40	4000K				
		50	5000K	DE	Double Wire End, End Cap Exit	IP54	IP54							

*Every linear profiles is supplied with 2 mounting clips

Example: LP10F-SL-D-1000-15-30-SE-IP40

LP10F Profile, Silver Anodised, Diffused lens, 1000mm, with FM8 - 15W/m, 3000K, Single Wire End at End Cap Exit, IP40, Including 2 x End Cap & 2 x Mounting Clip



LINEAR PROFILE AND ACCESSORIES

(Ordering Matrix for Separate Orders)

LP5F

Profile	Diffuser	Length
LP5F	D Diffused	500 500mm
		1000 1000mm
		2000 2000mm

Example: LP5F-D-1000
LP5F Profile, Diffused lens, 2000mm

End Cap

LP5F-EC

Example: LP5F-EC
LP5F End Cap

Mounting Clip

LP5F-MC

Example: LP5F-MC
LP5F Mounting Clip

LP10F

Profile	Diffuser	Length
LP10F	D Diffused	500 500mm
		1000 1000mm
		2000 2000mm

Example: LP10F-D-1000
LP10F Profile, Diffused lens, 2000mm

End Cap

LP10F-EC

Example: LP10F-EC
LP10F End Cap

Mounting Clip

LP10F-MC

Example: LP10F-MC
LP10F Mounting Clip

UniLink Mounting Clip

LP10F-UMC

Example: LP10F-UMC
LP10F UniLink Mounting Clip

Variable Angle Clip

LP10F-FMC

Example: LP10F-FMC
LP10F FlexiLink Mounting Clip

LP16F

Profile	Diffuser	Length
LP16F	D Diffused	500 500mm
		1000 1000mm
		2000 2000mm

Example: LP16F-D-2000
LP16F Profile, Diffused lens, 2000mm

End Cap

LP16F-EC

Example: LP16F-EC
LP16F End Cap

Mounting Clip

LP16F-MC

Example: LP16F-MC
LP16F Mounting Clip

UniLink Mounting Clip

LP16F-UMC

Example: LP16F-UMC
LP16F UniLink Mounting Clip

FlexiLink Mounting Clip

LP16F-FMC

Example: LP16F-FMC
LP16F FlexiLink Mounting Clip



LP10R

Profile	Diffuser	Length
LP10R	D Diffused	500 500mm
		1000 1000mm
		2000 2000mm

Example: LP10R-D-2000
LP10R Profile, Diffused lens, 2000mm

End Cap

LP10R-EC

Example: LP10R-EC
LP10R End Cap

Mounting Clip

LP10R-MC

Example: LP10R-MC
LP10R Mounting Clip

Spring Clip

LP10R-SC

Example: LP10R-SC
LP10R Spring Clip

UniLink Mounting Clip

LP10R-UMC

Example: LP10R-UMC
LP10R UniLink Mounting Clip

FlexiLink Mounting Clip

LP10R-FMC

Example: LP10R-FMC
LP10R FlexiLink Mounting Clip

MOUNTING METHOD

UniLink Mounting Clip

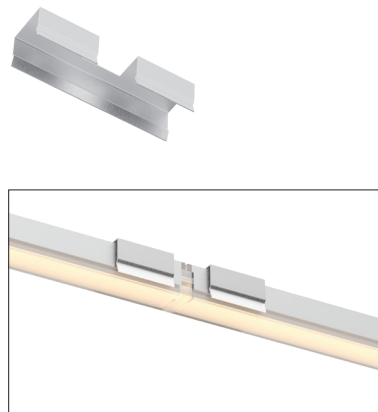

FlexiLink Mounting Clip

